

Curva 45° Raio Longo ANSI B16.9

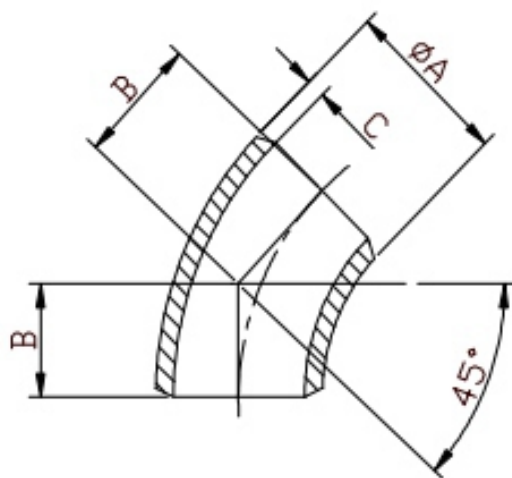

DN	A	B	C			
			SCH 5S.	SCH 10S.	SCH 40S.	SCH 80S.
1/2"	21.30	15.70	1.65	2.11	2.77	3.73
3/4"	26.70	19.10	1.65	2.11	2.87	3.91
1"	33.40	22.40	1.65	2.77	3.38	4.55
1.1/4"	42.20	25.40	1.65	2.77	3.56	4.85
1.1/2"	48.30	28.40	1.65	2.77	3.68	5.08
2"	60.30	35.10	1.65	2.77	3.91	5.54
2.1/2"	73.00	44.50	2.11	3.05	4.16	7.01
3"	88.90	50.80	2.11	3.05	5.49	7.62
4"	114.30	63.50	2.11	3.05	6.02	8.56
5"	141.30	79.20	2.77	3.40	6.55	9.53
6"	168.30	95.30	2.77	3.40	7.11	10.97
8"	219.10	127.00	2.77	3.76	8.18	12.70
10"	273.10	158.80	3.40	4.19	9.27	12.70
12"	323.90	190.05	3.96	4.57	9.53	12.70
14"	355.60	222.30	3.96	4.78		
16"	406.40	254.00	4.20	4.78		
18"	457.20	285.80	4.20	4.78		
20"	508.00	317.50	4.78	5.54		
22"	558.80	342.90	4.78	6.35		
24"	609.60	381.00	5.54	6.35		

Dimensões em mm.